







## STXN 90°

Reference	h=h1	b	L1	L2	f	Insert size						
STXN R/L 1212 F16	12	12	80	25	16	16 ER/L..	0,100	SA3T	5510	YE3	YI3	SY3
STXN R/L 1616 H16	16	16	100	25	20	16 ER/L..	0,200	SA3	5510	YE3	YI3	SY3
STXN R/L 2020 K16	20	20	125	28	25	16 ER/L..	0,400	SA3	5510	YE3	YI3	SY3
STXN R/L 2525 M16	25	25	150	28	32	16 ER/L..	0,700	SA3	5510	YE3	YI3	SY3
STXN R/L 3232 P16	32	32	170	28	40	16 ER/L..	1,050	SA3	5510	YE3	YI3	SY3
STXN R/L 2525 M22	25	25	150	34	32	22 ER/L..	0,700	SA4	5520	YE4	YI4	SY4
STXN R/L 3232 P22	32	32	170	34	40	22 ER/L..	1,300	SA4	5520	YE4	YI4	SY4
STXN R/L 4040 R22	40	40	200	34	50	22 ER/L..	3,000	SA4	5520	YE4	YI4	SY4
STXN R/L 2525 M27	25	25	150	34	32	27 ER/L..	0,700	SA5	5525	YE5	YI5	SY5
STXN R/L 3232 P27	32	32	170	34	40	27 ER/L..	1,300	SA5	5525	YE5	YI5	SY5
STXN R/L 4040 R27	40	40	200	34	50	27 ER/L..	3,000	SA5	5525	YE5	YI5	SY5
STXN R/L 5050 S27	50	50	250	34	60	27 ER/L..	5,800	SA5	5525	YE5	YI5	SY5

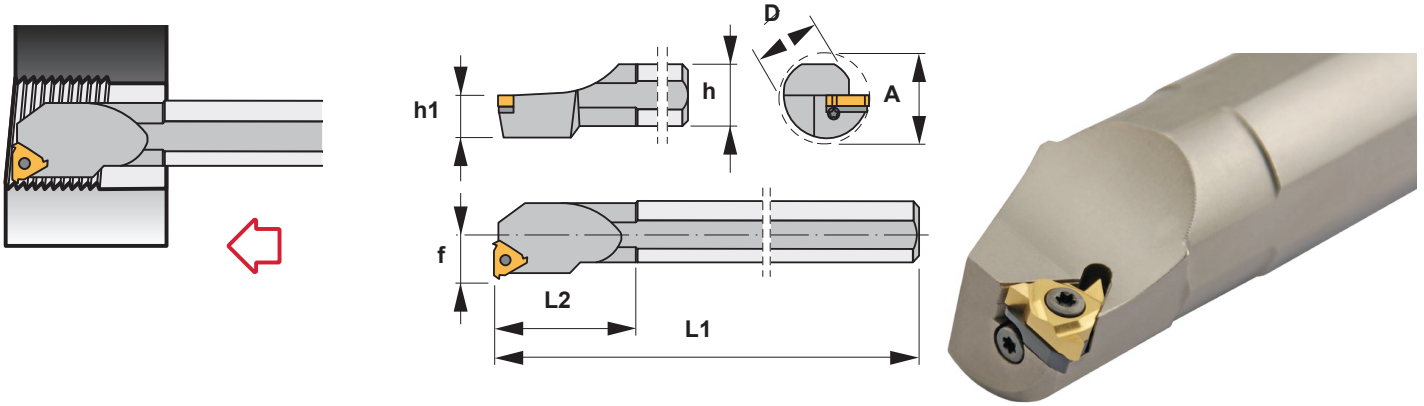

## STXN 90°

Reference	D	h	h1	L1	L2	f	A	Insert size	Kg						Nm
S10K STXN R/L 11	10	9	4,5	125	16	7,3	13	11 NR/L..	0,070	1225	5507	-	-	-	0.9
S16M STXN R/L 11	16	15	7,5	150	25	8,9	16	11 NR/L..	0,200	1225	5507	-	-	-	0.9
S16M STXN R/L 16	16	15	7,5	150	30	11,5	20	16 NR/L..	0,200	SN3	5510	-	-	-	2.0
S20Q STXN R/L 16	20	18	9,0	180	35	13,4	24	16 NR/L..	0,400	SA3T	5510	YI3	YE3	SY3	2.0
S25R STXN R/L 16	25	23	11,5	200	40	16,3	29	16 NR/L..	0,700	SA3	5510	YI3	YE3	SY3	2.0
S32S STXN R/L 16	32	30	15,0	250	45	19,6	36	16 NR/L..	1,500	SA3	5510	YI3	YE3	SY3	2.0
S40T STXN R/L 16	40	37	18,5	300	50	23,8	44	16 NR/L..	2,850	SA3	5510	YI3	YE3	SY3	2.0
S20Q STXN R/L 22	20	18	9,0	180	35	15,6	27	22 NR/L..	0,400	SN4	5520	-	-	-	4.0
S25R STXN R/L 22	25	23	11,5	200	40	17,2	32	22 NR/L..	0,700	SA4	5520	YI4	YE4	SY4	4.0
S32S STXN R/L 22	32	30	15,0	250	45	21,5	39	22 NR/L..	1,500	SA4	5520	YI4	YE4	SY4	4.0
S40T STXN R/L 22	40	37	18,5	300	50	25,8	47	22 NR/L..	2,850	SA4	5520	YI4	YE4	SY4	4.0
S32S STXN R/L 27	32	30	15,0	250	45	22,4	40	27 NR/L..	1,500	SA5	5525	YI5	YE5	SY5	5.0
S40T STXN R/L 27	40	37	18,5	300	50	26,4	48	27 NR/L..	2,850	SA5	5525	YI5	YE5	SY5	5.0
S50U STXN R/L 27	50	47	23,5	350	60	31,4	58	27 NR/L..	5,200	SA5	5525	YI5	YE5	SY5	5.0
S60V STXN R/L 27	60	57	28,5	400	60	36,4	69	27 NR/L..	8,550	SA5	5525	YI5	YE5	SY5	5.0